

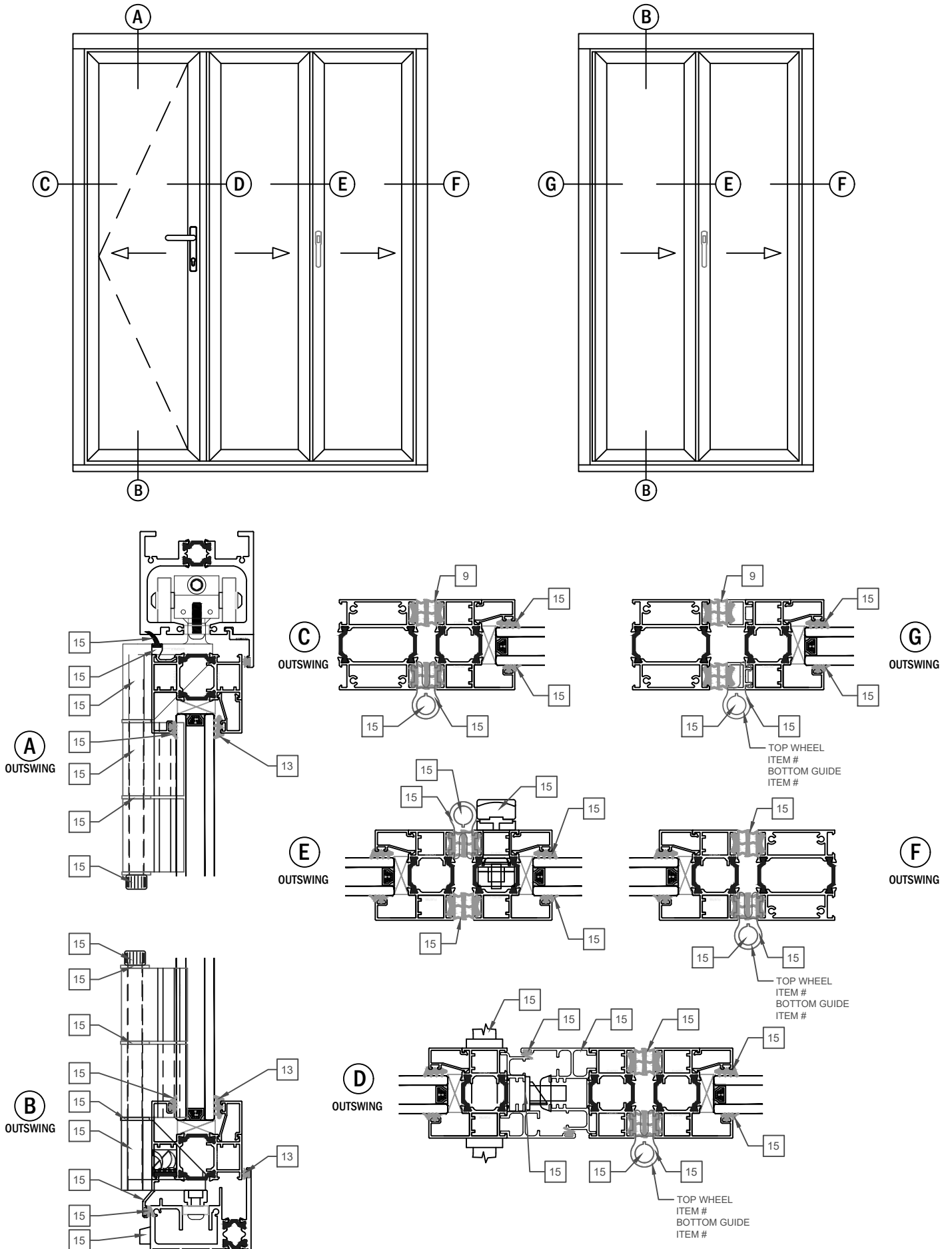

# PINNACLE SELECT BI-FOLD (Aluminum Interior)

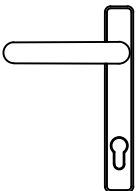

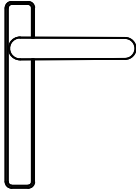









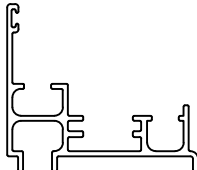
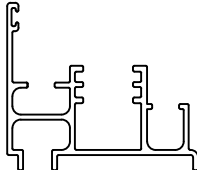

## PART LIST



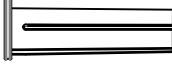

# PINNACLE SELECT BI-FOLD (Aluminum Interior)

| IMAGE   | ITEM # | DESCRIPTION   | TYPE   | PART #   |
|---|--------|---|--|--|
|     | 1      | <p>ARIA HANDLE (ACTIVE PANEL)</p> <p>ACACIA HANDLE (ACTIVE PANEL)</p> <p>SUMMIT HANDLE (ACTIVE PANEL)</p>       | <p>BLACK<br/>BRONZE<br/>WHITE<br/>SATIN CHROME</p> <p>BLACK<br/>BRONZE<br/>WHITE<br/>SATIN CHROME</p> <p>BLACK<br/>BRONZE<br/>WHITE<br/>SATIN CHROME</p> | <p>48000<br/>48001<br/>48002<br/>48003</p> <p>48004<br/>48005<br/>48006<br/>48007</p> <p>48008<br/>48009<br/>48010<br/>48011</p> |
|    | 2      | <p>ARIA HANDLE (INACTIVE PANEL)</p> <p>ACACIA HANDLE (INACTIVE PANEL)</p> <p>SUMMIT HANDLE (INACTIVE PANEL)</p> | <p>BLACK<br/>BRONZE<br/>WHITE<br/>SATIN CHROME</p> <p>BLACK<br/>BROWN<br/>WHITE<br/>SATIN CHROME</p> <p>BLACK<br/>BRONZE<br/>WHITE<br/>SATIN CHROME</p>  | <p>48012<br/>48013<br/>48014<br/>48015</p> <p>48016<br/>48017<br/>48018<br/>48019</p> <p>48020<br/>48021<br/>48022<br/>48023</p> |
|   | 3      | LOCKING MECHANISM (ACTIVE PANEL)  | <p>3-POINT LOCK</p> <p>4-POINT LOCK</p>  | <p>48066</p> <p>48067</p>  |
|  | 4      | LOCKING MECHANISM (INACTIVE PANEL)  | 2-POINT LOCK   | 48068  |
|   |        |   |  |  |

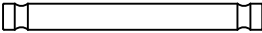
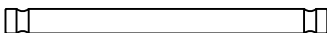
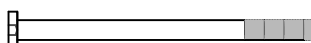
# PINNACLE SELECT BI-FOLD (Aluminum Interior)

| IMAGE   | ITEM # | DESCRIPTION                            | TYPE            | PART # |
|---|--------|--|-----------------|--------|
|    | 5      | ALUM. SIDE HINGE                       | PC TO MATCH     | 48069  |
|    | 6      | ALUM. BIPART BOTTOM/TOP HINGE          | PC TO MATCH     | 48070  |
|    | 7      | PRIMARY ASTRAGAL                       | PC TO MATCH     | 48072  |
|    | 8      | SECONDARY ASTRAGAL                     | PC TO MATCH     | 48073  |
|    | 9      | BOTTOM PANEL CLIP<br>FOR SURFACE TRACK | PC TO MATCH     | 48074  |
|    | 10     | PANEL EDGE CLIP                        | PC TO MATCH     | 48075  |
|   | 11     | JOINT GASKET                           | BLACK           | 48076  |
|  | 12     | EXT. GLAZING GASKET                    | BLACK           | 48077  |
|  | 13     | INT. GLAZING GASKET                    | BLACK           | 48078  |
|  | 14     | FIN GASKET                             | BLACK           | 48079  |
|  | 15     | PANEL RAIL GASKET                      | BLACK           | 48037  |
|  | 16     | SMALL BASE FELT BRUSH                  | BLACK           | 48064  |
|  | 17     | DRAINAGE CAP                           | BLACK           | 48039  |
|  | 18     | HINGE SLEEVE                           | BLACK           | 48080  |
|  | 19     | HINGE WASHER                           | BLACK           | 48081  |
|   | 20     | HINGE PIN                              | STAINLESS STEEL | 48082  |
|   | 21     | PULL HANDLE HINGE PIN                  | STAINLESS STEEL | 48083  |
|   | 22     | TOP/BOTTOM ROLLER GUIDE PIN            | STAINLESS STEEL | 48084  |
|   |        |  |                 |        |

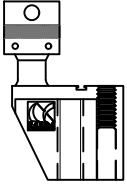
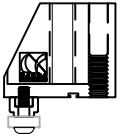
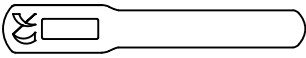
# PINNACLE SELECT BI-FOLD (Aluminum Interior)

| IMAGE   | ITEM #   | DESCRIPTION   | TYPE                       | PART #         |
|---|----------|---|----------------------------|----------------|
|  | 23<br>24 | ALUM. TOP ROLLER GUIDE<br>ALUM. BIPART TOP ROLLER GUIDE       | PC TO MATCH<br>PC TO MATCH | 48085<br>48086 |
|  | 25<br>26 | ALUM. BOTTOM ROLLER GUIDE<br>ALUM. BOTTOM BIPART ROLLER GUIDE | PC TO MATCH<br>PC TO MATCH | 48087<br>48088 |
|   | 27       | SELECT 100 HANDLE   | PC TO MATCH                | 48091          |
|   | 28       | SELECT 100 MECHANISM  | ZINC ALLOY                 | 48092          |
|   |          |   |                            |                |