

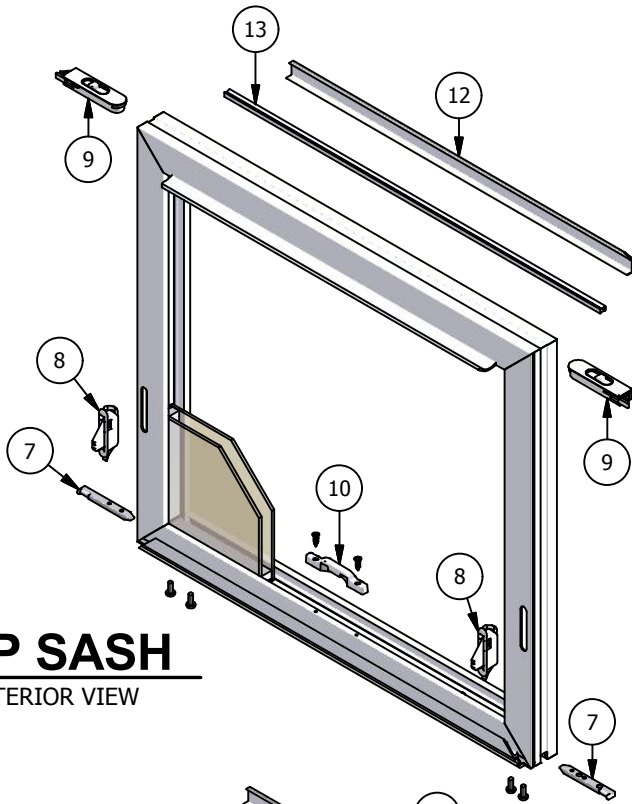

Revive Series Vinyl Double Hung (Operating) Parts Identification

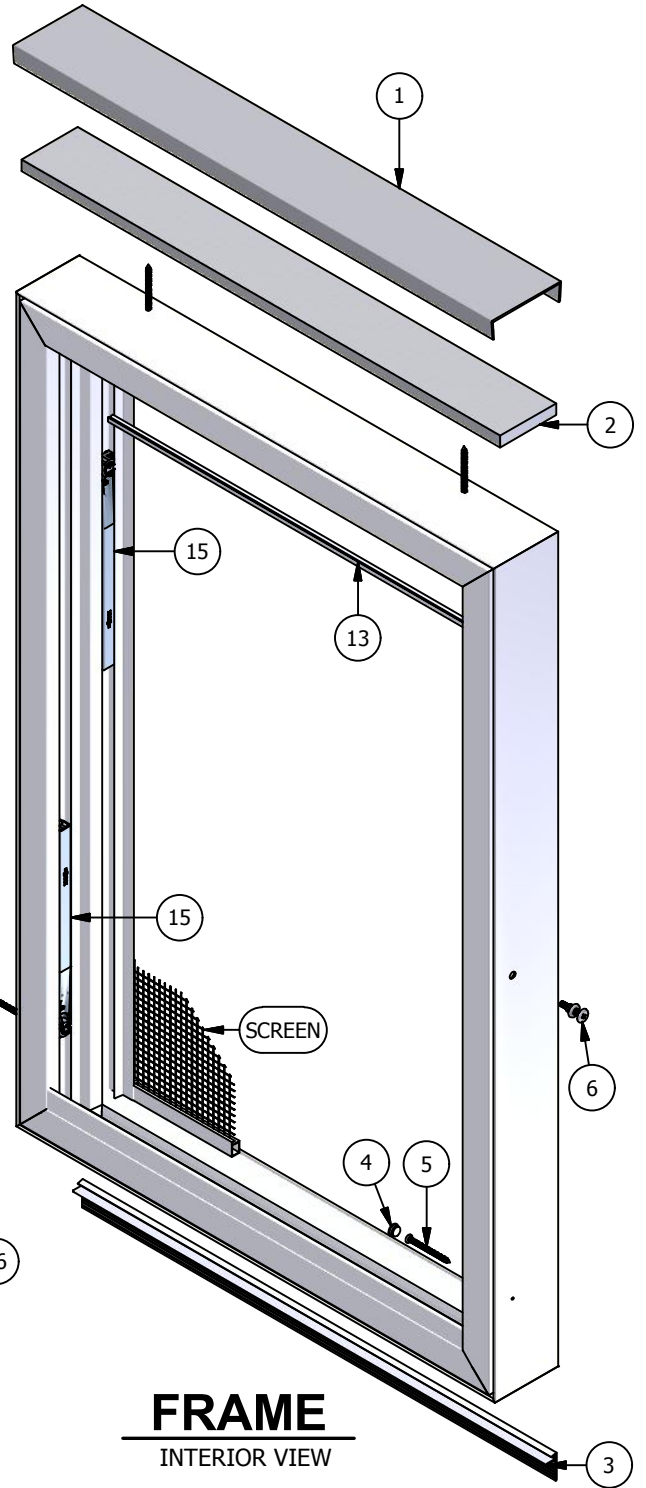

TOP SASH
INTERIOR VIEW



FRAME
INTERIOR VIEW

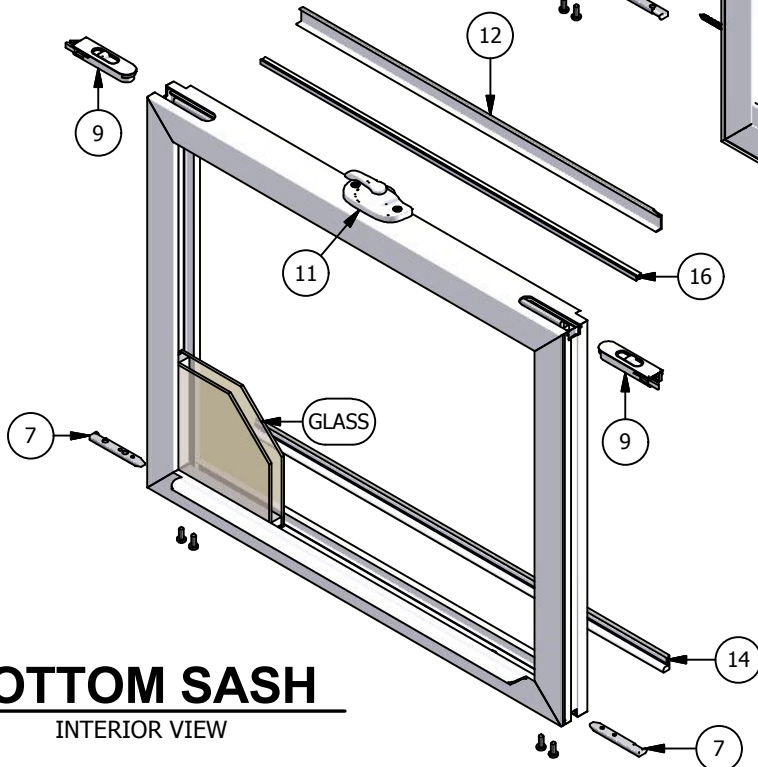







BOTTOM SASH
INTERIOR VIEW



Revive Series

Vinyl Double Hung (Operating)

Parts Identification

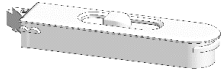
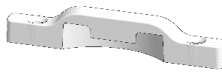
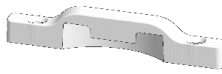
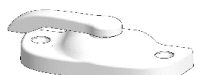

Image	Item #	Description	Color / Finish	Spec	Old	New SAP
	1	Head Expander (Qty. 1)	White Clay		900755 901855	10054630 10054252
	2	Head Expander Foam (Qty. 1)			2388409	10054569
	3	Sill Cover (Qty. 1)	White Clay		900760 901860	10054722 10054055
	4	Hole Cap (Qty. 4)	White Clay Black		558242 558245 558529	10054614 10054692 10054354
 Not Shown on Assembly Dwg	5	Frame Screw #8 x 2" (Qty. 4)			518200	10056223
	6	Jamb Jack (Qty. 2)			558240	10054691



Revive Series

Vinyl Double Hung (Operating)

Parts Identification



Image	Item #	Description	Color / Finish	Spec	Old	New SAP
	7	Tilt Pin	Grey		931058	10054647
		Tilt Pin Screws #6 x 1/2" Screw	White		971001	10056613
			Clay		971010	10056615
			Black		971002	10075513
	8	Vent Latch	White		941023	10054427
			Clay		941024	10054271
			Black		941025	10056602
	9	Tilt Latch (LH Shown)	White	LH	941004	10054430
			White	RH	941003	10054759
			Clay	LH	941006	10054431
			Clay	RH	941005	10054157
			Black	LH	940998	10054565
			Black	RH	940999	10054429
	10	Keeper	White		941101	10054802
			Clay		941103	10054428
		Keeper Screws #4 x 3/4" Screw	Black		941105	10054156
			White		971009	10055089
	11	Lock	White		941100	10054553
			Clay		941102	10054761
			Black		941104	10054267
		Lock Screws #6 x 5/8" Screw	White		508085	10056199
			Clay		538080	10056701
			Black		508039	10056859
	12	Glazing Bead	White	16'	920009	10055282
			Clay		920044	10054413
			Bronze		920009-BZ	10116681
			Black		920009-BK	10116682
			Tan		920009-T	10116678
			Ivory		920009-I	10116680
			Cinnamon		920009-C	10116679
			Green		920009-G	10116676
			Green		920009-G	10116676
			White		920009-W	10116677



Revive Series

Vinyl Double Hung (Operating)

Parts Identification

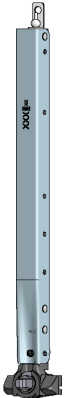
Image	Item #	Description	Color / Finish	Spec	Old	New SAP
	13	Weatherstrip Not Used on Bottom Sash Meeting Rail	White	FT	951001	10056991
			Clay	FT	951002	10054763
			Black	FT	951000	10054650
	14	Bottom Rail Weatherstrip	White	FT	951003	10054566
			Clay	FT	951004	10054803
			Black	FT	951005	10054764
	15	Inverted Block and Tackle Balance	*See Inside Sales for more Information	08A	929000	10055688
				08B	929001	10056515
				10A	929005	10054731
				10B	929006	10054881
				10C	929007	10056741
				12A	929014	10054635
				12B	929015	10054732
				12C	929016	10054562
				12D	929017	10055283
				14A	929023	10054793
				14B	929024	10054733
				14C	929025	10054636
				14D	929026	10054734
				15D	929033	10056521
				16A	929036	10054587
				16B	929037	10054735
				16C	929038	10054637
				16D	929039	10055284
				16E	929040	10056522
				18A	929076	10054736
				18B	929077	10054542
				18C	929078	10054794
				18D	929079	10054737
				18E	929080	10056524
				20A	929117	10054588
				20B	929118	10054795
				20C	929119	10054739
20D	929120	10054639				
20E	929122	10056526				
22A	929160	10054740				
22B	929161	10054563				
22C	929162	10054796				
22D	929163	10054741				
22E	929165	10056530				
22F	929166	10055696				
23B	929182	10054926				
23C	929183	10054640				
23D	929184	10054742				
23E	929185	10056744				
24A	929202	10054589				
24B	929203	10055697				
24C	929204	10054743				
24D	929205	10054641				
24E	929207	10054744				
24F	929208	10056533				



Revive Series

Vinyl Double Hung (Operating)

Parts Identification

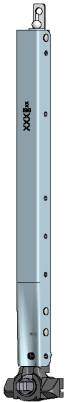

Image	Item #	Description	Color / Finish	Spec	Old	New SAP
	15	Inverted Block and Tackle Balance	*See Inside Sales for more Information	26A	929296	10056541
				26B	929247	10056537
				26C	929248	10054642
				26D	929249	10054746
				26E	929251	10055288
				26F	929252	10056538
				28A	929289	10054747
				28B	929290	10054643
				28C	929291	10054748
				28D	929292	10054564
				28E	929294	10054798
				28F	929295	10055701
				30A	929333	10054749
				30B	929334	10054644
				30C	929335	10056545
				30D	929336	10054750
				30E	929338	10055290
				30F	929339	10056546
				32A	929370	10054751
				32B	929371	10054645
				32C	929372	10055705
				32D	929373	10054752
				32E	929375	10056549
				32F	929376	10054545
				32G	929377	10055291
				32H	929378	10056550
				34B	929402	10054979
				34C	929403	10054753
				34D	929404	10054646
				34E	929406	10056748
				34F	929407	10056556
				34G	929408	10055709
				34H	929409	10056557
				36B	929433	10056749
		36C	929434	10054754		
		36D	929435	10054592		
		36E	929437	10056564		
		36F	929438	10055713		
36G	929439	10056565				
38B	929464	10054980				
38C	929465	10056750				
38D	929466	10054800				
38E	929467	10056572				
38F	929468	10055717				
38G	929469	10056573				
38H	929470	10055297				
		Balance Screw (#6 x 5/8")			583125	10053112
		Balance Shoe			931176	10054756



Revive Series

Vinyl Double Hung (Operating)

Parts Identification

Image	Item #	Description	Color / Finish	Spec	Old	New SAP
	16	Meeting Rail Weatherstrip	White Clay Black	FT FT FT	478067 478073 531102	10057107 10054322 10057173
No Image		Meeting Rail Corner Pad Cut to 1/2" x 1/2" - (Qty 2)	White Black	LF LF	951015 951016	10054594 10054159
No Image		Glazing Tape 1/16" x 1/2"	White Black	216' Roll 216' Roll	394100 394099	10055200 10056179
 Not Shown on Assembly Dwg		Window Opening Control Device (Includes screws & Instructions) Field Applied Only	White Clay		941008 941009	10054649 10054760