

# INSTALLATION GUIDELINES

## For Pinnacle Multi-Slide Patio Doors

### Installer

- Read instructions completely before attempting installation. Failure to follow these guidelines will forfeit all Windsor warranty coverage (written or implied). Windsor Windows & Doors will not be held responsible for any claims or damages resulting from installation.
- Always provide a copy of these instructions to the homeowner.
- These instructions are consistent with ASTM 2112 "Standard Practice for Installation of Exterior Windows, Doors and Skylights" into common wall constructions. For installation into air barrier sheathing systems such as ZIP System, refer to our supplemental installation instructions at [www.windsorwindows.com](http://www.windsorwindows.com). Contact your architect or construction professional for installation into other building designs or construction methods.
- Structural support of the sill is required to support the entire sill width, and depth of the sill's interior edge, to the exterior nose of the sill extrusion. If the architect's details do not include this type of structural support, a structural support must be installed and flashed.
- Regional codes and environmental conditions may require installation that is different from these guidelines. It is your responsibility to ensure that local codes and ordinances are followed.

### Warning

- ⚠ **Work Safe!** Always wear proper eye and hearing protection when installing or adjusting Windsor products.
- ⚠ **Use Power Tools Properly!** To avoid personal injury, always follow manufacturers' instructions for safe operation of power tools.
- ⚠ **Ladder Safety!** Working at elevated levels can be hazardous. Always use ladders and scaffolding properly. Consult manufacturers' guidelines for safe use of these types of equipment.

### Important

- Windsor reserves the right to change the information contained in these guidelines without notice.
- Maintain a minimum of 1/4" between the door frame and any trim, siding or masonry.
- Use of Windsor products in barrier EIFS systems (synthetic stucco) is not recommended. To do so will forfeit all warranties (written or implied). Windsor Windows & Doors will not be held responsible for any claims or damages resulting from water infiltration.
- Steel fasteners will corrode when used with ACQ pressure treated lumber. Use corrosion resistant fasteners (such as stainless steel) when installing doors in or around these types of materials.
- Door nailing flanges and drip caps (integral or applied) do not take the place of door flashing. All windows and doors must be properly flashed and sealed around the perimeter.



[www.windsorwindows.com](http://www.windsorwindows.com)

## Handling and Storage

**CAUTION:** Prefinished Interiors: Windsor products with prefinished interiors must be protected from dents, scratches, scrapes or other blemishes. Windsor does not warrant against dents, scratches, scrapes or other damage to prefinished interiors after the Windsor products leave Windsor's possession.

After the Windsor products leave Windsor's possession, extreme care must be taken by those moving the doors, or those working on or around the doors, to protect prefinished interiors from dents, scratches, scrapes or other blemishes.

### Follow these procedures for proper storage and handling of windows and doors:

- **Remove stretch wrap immediately so the individual units can be exposed to circulated air.**
- **Do not store units outside or in direct sunlight. Allow sufficient spacing between products for ventilation.**
- **Never store units in a closed truck or other similar enclosure where the units can get too hot.**
- **Never stack or lean units against each other in the sun.**
- **Always store units vertically. Do not store units flat or stack horizontally.**
- **Units must be stored in a clean, dry, well-ventilated and enclosed area.**
- **Units with unsupported nailing fins should have their corners blocked and protected to prevent damage to the nailing fin.**
- **Always carry door units upright. Do not carry flat! Doing so could result in damage to the unit.**

**Failure to follow these procedures will void our product warranty.**

### Tools Needed

- Safety Glasses
- Utility Knife
- Hammer (or nail gun)
- Caulk Gun
- Level
- Ladder / Scaffolding
- Square
- Tape Measure
- Drill / Screwdriver (#2 square bit)
- 7/16" Wrench



### Materials Needed

- Insulation
  - Minimally expanding low pressure polyurethane window and door foam
- Shims
  - Made of cedar or synthetic material
- Coated Deck Screws
  - 1-1/2" x #8
- Sealant
  - 100% Silicone
- Flashing
  - Self-adhesive flexible flashing that complies with AAMA-711
- White Petroleum Jelly (Vaseline®)
- **Sill Pan (Required)**

## LEAD PAINT AND EXISTING DOOR DISPOSAL:

- A) Before any remodel or renovation, make sure to identify any potential lead paint issues and take necessary steps to reduce the risk of lead contamination.
- B) The U.S. Environmental Protection Agency (EPA) has issued a “Lead Renovation, Repair and Painting Rule (RRP)” for remodelers of older homes and buildings. This rule requires training and certification in lead-safe work practices for firms performing renovation, repair or painting on homes and child-occupied facilities built prior to 1978.
- C) For more information regarding procedures for dealing with lead paint, please visit EPA’s website at [www.epa.gov/lead](http://www.epa.gov/lead).
- D) When removing existing doors, make sure to wear appropriate personal protective equipment. Extra precautions should be taken to protect others and property within the vicinity and below the removal door and surrounding components.
- E) Consult with local waste authorities on the proper recycling or disposal of old door components.

**ATTENTION! ARBITRATION AGREEMENT; JURY TRIAL WAIVER; CLASS ACTION WAIVER.** By purchasing, installing or using this product, you agree to arbitrate any dispute you may have with Windsor relating to your Windsor products, and to waive your rights to a jury trial and to participate in class-action or class-arbitration proceedings, relating to any such disputes. For more details, and to learn how **YOU CAN OPT OUT OF THIS ARBITRATION AGREEMENT AND THESE WAIVERS**, please go to [www.windsorwindows.com/support/DisputeResolution](http://www.windsorwindows.com/support/DisputeResolution).

---

## Items Provided by Windsor Windows & Doors

- **Frame parts**
  - Head jamb, side jambs and sill (to be assembled in field)
  - Post interlock (for pocket doors only)
- **Door panels**
  - Lead panel (main locking panel)
  - Intermediate panels (quantity will depend on unit configuration ordered)
  - Pocket/stacking panel (will depend on unit configuration ordered)
- **Screw packs**
  - Frame assembly
  - Nosing
  - Sill install
  - Head/side jamb
  - L-bracket
  - Post interlock (pocket doors only)
  - Follower (pocket doors only)
- **Frame track covers**
  - Head track covers (quantity will depend on unit configuration ordered)
  - Side jamb track covers (quantity will depend on unit configuration ordered)
- **Frame gaskets (head and sill)**
- **Handle set (applied to lead panel)**
- **Construction handle**
- **Collector plates**
- **L-brackets**
- **Aluminum panel follower (pocket door only)**
- **Wood pocket cover for aluminum panel follower (pocket door only)**
- **Foam corner seals for nail fin**
- **Frame nosing corner seals**
- **Nail fins – head, side, post interlock**

## Step 1: Inspect Unit

### Before Installation

- A) Remove all shipping packaging material (blocks, pads, protectors, stretch wrap).
- B) Inspect unit for any damage or defects.
- C) Verify that the door unit is the correct size and configuration.
- D) Contact the nearest Windsor distributor if there are any problems.

## Step 2: Opening Inspection

### Verify Header Support

Confirm that the roof over the system is stacked and take into consideration the amount of weight of any materials at this location that may cause deflection of the header. No more than 1/8" deflection is allowable for proper system operation. The material/lumber quality and the fasteners must be structurally adequate for design load requirements. (Fig. 1)

Verify that the concrete or sub-floor of the rough opening is level. The frame system may be shimmed to compensate for an uneven floor, but this may adjust the relationship of the system sill to the finished floor and may increase the overall height of the system in the opening. Any serious deflection in the concrete or sub-floor where the system is to be installed must be corrected prior to installation. **Sill must be within 1/8" of level for every 10' of sill length.** (Fig. 2)

Assure that all opening measurements match those noted on the drawings that are provided with the system. (Fig. 3)

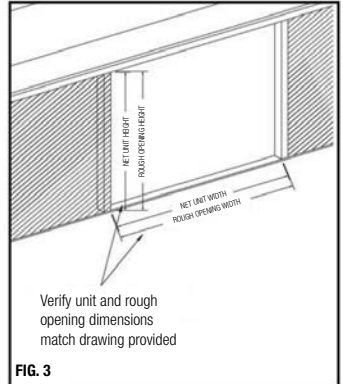
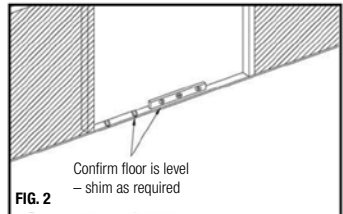
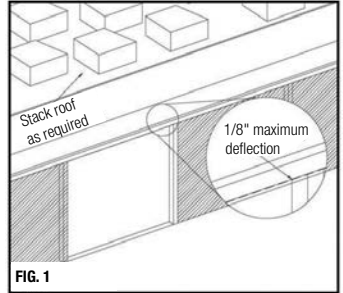

## Prepare Rough Opening

- A) Measure and verify the size of the rough opening. The rough opening should be 1/2" larger than the frame in height and 3/4" larger in width.
- B) Verify the rough opening is plumb, level and square. For doors with clad exterior casings, additional nailer studs may be required around the perimeter of the rough opening. (Fig. 4)
- C) Take diagonal measurements to check for square. (Fig. 4)
- D) Make sure the bottom sill area of the rough opening is flat and level. Correct rough opening if sloped toward the interior, out of level or humped. (Fig. 4) **Sill must be within 1/8" of level for every 10' of sill length.**
- E) Cut the weather-resistant barrier (WRB) along the perimeter of the rough opening. Ensure the WRB is cut flush with the sheathing and is not wrapped into the rough opening. (Fig. 5)
- F) From the exterior, cut the top of the WRB to form a flap. (Fig. 5)
- G) Temporarily tape this top flap up. (Fig. 6)

## Pockets (For pocket doors only)

- A) The exterior building wall should be finished according to your exposure to the weather and local building codes.
- B) The pocket cavity should not be sheathed until the frame is installed.
- C) It is recommended that the pocket cavity be painted black.
- D) The post interlock seals the doors to the building and are supplied with the unit. They also require a continuous plane of building material for mounting. (Fig. 4)

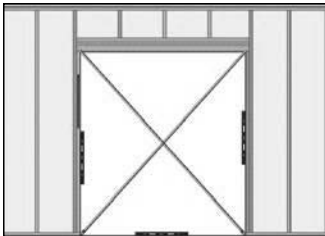

FIG. 4

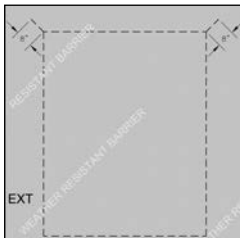

FIG. 5

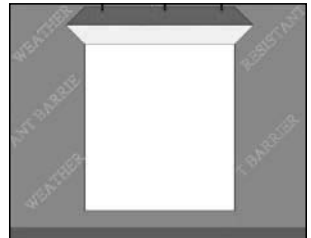

FIG. 6

## Flashing Requirements

Follow ASTM E 2112 guidelines for sealing and flashing exterior doors. Maintain a gap of at least 1/2" between the door frame and the rough opening structure. Create a proper seal between the door and the building exterior. **A sill pan is REQUIRED.**

### Step 3: Sill Pan Flashing

- A) Make sill pan to rough opening dimensions and dry fit it in the opening. The rear leg is required to be a minimum of 3/4" high. (Fig. 7)
- B) Install and attach sill pan to rough opening per ASTM-E 2112 standards, making sure that the sill pan is level once installed.

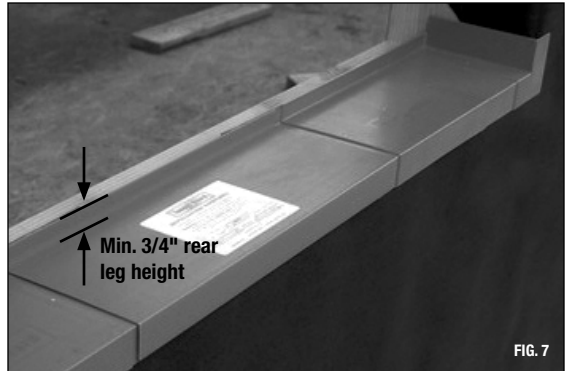

### Step 4: Frame Assembly

- A) Install gaskets on the top and bottom of both frame sides and stucco nosing as shown **circled** on Fig. 9. For a pocket door, install the post interlock gaskets as well.
- B) Make sure you have a clean flat surface to help protect the frame when assembling. Lay frame head, sill, side jamb(s) and post interlock(s) on the clean flat surface with the exterior side up.
- C) Attach the side jamb(s) to the head using the screws supplied in the "Frame Assembly" screw package. Make sure the screws pass through the side jambs and into the screw bosses in the head (**on the pocket side of a pocketing unit, the base side jamb is not supplied with the exterior nosing; this nosing called the post interlock will be applied in the steps that follow.**) (Fig. 8)

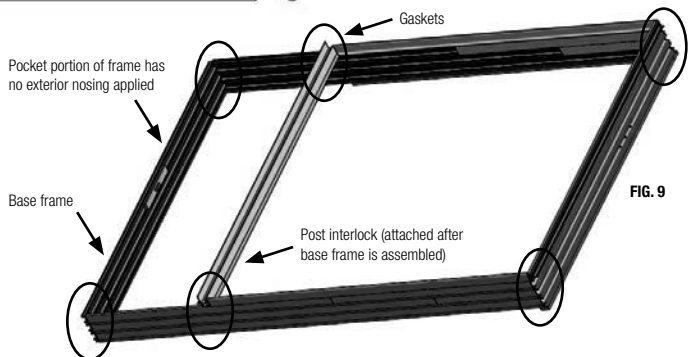

- D) Attach the side jamb(s) to the sill using the screws supplied in the “Frame Assembly” screw package. Make sure the screws pass through the side jambs and into the screw bosses in the sill nosing. (Fig. 8)
- E) Align the pre-drilled hole on the post interlock (Fig. 9) to the holes on the exterior of the pocket side of the frame (the post interlock should line up flush with the frame nosing at the head). Secure the post interlock to the frame sill using the provided screw in the “Post Interlock” screw package. (Fig. 10) **Do not over-tighten screws. Over-tightening the screws will cause the post interlock to collapse at the ends.**

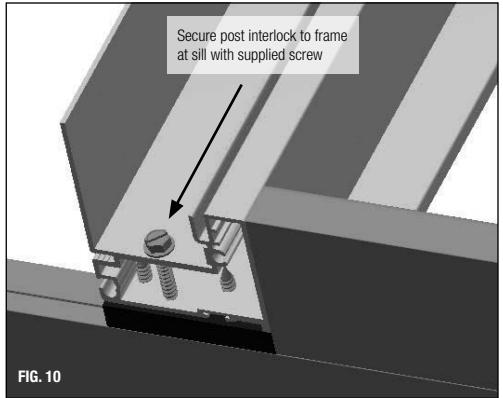

### Step 5: Frame Preparation

- A) On each end of the sill, fill the small gap between the sill nosing and the interior wood trim on the interior of the side jamb with sealant. (Fig. 11)

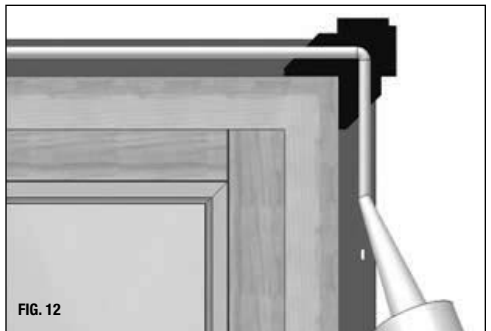
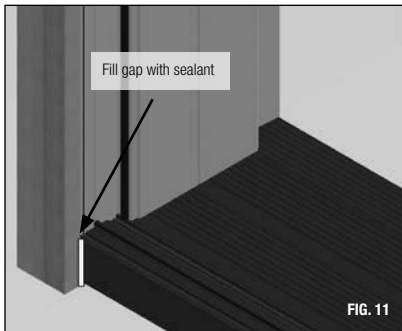

- B) Apply the foam corner seal to the nailing fin on each corner at the head of the unit. (Fig.12)
- C) Run a bead of sealant on the backside of the nail fin on the head and sides as shown in Fig. 12.
- D) Apply a 3/16" bead of sealant on the interior upturned leg of the sill pan where the back of the sill will contact the sill pan. (Fig. 13)

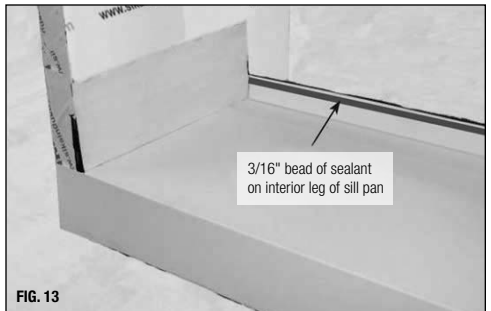

## Step 6: Frame Installation

For Impact-rated products and/or any products installed in the Florida or Texas TDI regions, supplemental anchoring methods may be required. Refer to supplemental instructions attached to unit or [www.windsorwindows.com](http://www.windsorwindows.com) for further information.

- A) Drill wood sub-floor through the factory pre-drilled holes located in the sill. For masonry application, Tapcon screws are required and are supplied by others. Using a straight edge or level, verify that the sill is level and flat. Use shims as needed to flatten the sill. Apply sealant in each pre-drilled hole in the sill. Attach using fasteners located in the "Sill Install" screw package.
- B) Prior to attaching the head, square the frame to within the allowable tolerances. Using a straight edge and/or level, verify that the top track/head is level and flat. Use shims as needed to level and flatten the head. Attach the head through the pre-drilled holes using the screws located in the "Head Jamb Install" screw package.
- C) Using a straight edge and/or level, verify that the side jambs are level and flat. Use shims as needed to level and flatten the jambs. Attach the side jambs through the factory pre-drilled holes using the screws located in the "Head Jamb install" screw package. There will be two screws with rubber bumpers applied in the accessory kit per jamb cavity that accepts a door in the open position. These screws need to be applied to the top and bottom holes of each cavity.
- D) Cross measure the frame to confirm there is no variance larger than 1/8" per measurement and that the frame is square to within 1/8" horizontally and vertically. (Fig. 14)
- E) Set the frame into the rough opening. Center the frame in the opening, making sure there are equal gaps on both sides of the frame.
- F) Temporarily tack the frame into place using 1-1/2" x #8 coated deck screw on one top corner of the nailing flange.
- G) Check the unit for square using diagonal measurements. Shim frame to ensure the unit is square. Check the unit for square. The difference between the diagonal measurements shall not exceed 3/16". (Fig. 14)
- H) Screw all four corners in place through the nailing flange using 1-1/2" x #8 coated deck screws.
- I) Make sure jambs, head & sills are straight. Additional shimming will be required.
- J) Shim jambs at each corner. Add additional shims at side jamb no more than 24" apart. See (Fig. 15) for minimum shim placement.

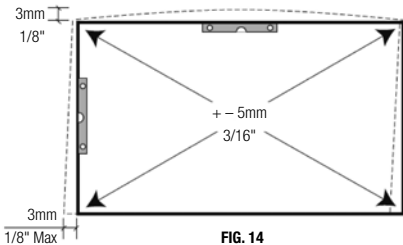

FIG. 14



FIG. 15



## Step 7: Panel Installation (Installed from the Exterior)

- A) All panel types are identified with a sticker (lead, intermediate, stacking or pocket). Install the collector plates on the intermediate panels as shown in Fig. 16.
- B) Beginning with lead panel, holding the panel at an angle toward the head track, insert the top of the panel into the inner most head track and swing the bottom of the panel inward until it is parallel with the top and sits with the wheels on the corresponding sill as shown in Fig. 17.



FIG. 16

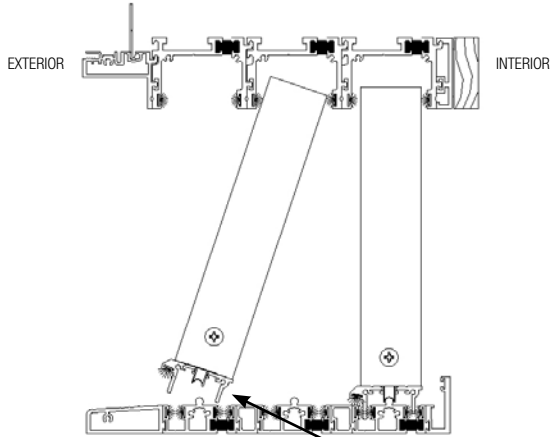

FIG. 17

LIFT the panels over the tracks to prevent damaging the sill

- C) Maintain space between lead panel and the side jamb to avoid interference with the intermediate panel interlock. Install intermediate panels next. Install pocket or stacking panels last. (Fig. 18)



FIG. 18

## Step 8: Follower/Pocket Closure Installation (For Pocketing Systems Only)

- A) Attach the aluminum follower to the back edge of the pocket panel (most exterior panel). Line up the holes/slots in the aluminum follower with the pre-drilled holes in the edge of the panel. Secure the aluminum follower in place by inserting the lag bolt and washer (found in the “follower” screw package) through the hole on the back edge of the aluminum follower and into the pre-drilled holes on the edge of the panel and tightening. (The washers need to be between the aluminum follower and the head of the bolt. Repeat for each pre-drilled hole.) **Do not install the pocket cover if the panels will need to be removed for finishing.**
- B) Attach the panel follower trim to the aluminum follower using the supplied screws in the “Interlock” screw package. (Fig. 19)

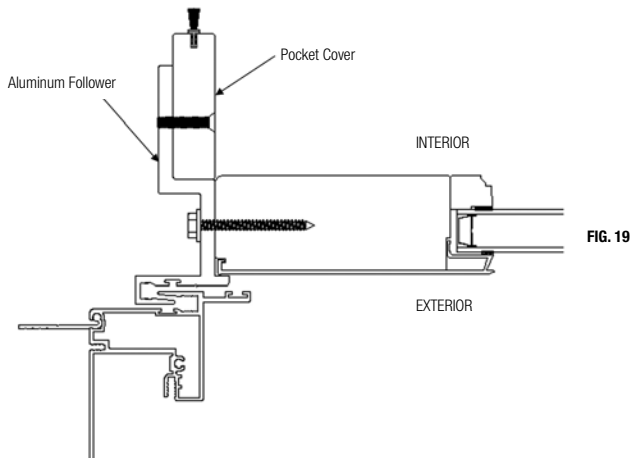

## Step 9: Adjustments

- A) Once all panels are installed, close the system and make sure all panel stiles line up properly by adjusting wheels for proper alignment. Wheel adjustments should be used for final tuning only.
- B) Slide the lock side of the active panel within 1/16" from the side jamb interior stop. The gap between the edge of the panel and inside stop must be consistent along the vertical length of the panel. If this is not the case with your unit, you must make adjustments to the rollers. The rollers can be adjusted with a screwdriver on the screws located at the base, on the edges of the panel. Turning the screw in one direction will raise or lower that side of the panel. (Fig. 20) Taking the weight off the rollers will allow for easier adjustment.
- C) Adjust keeper if needed. (Fig. 21)

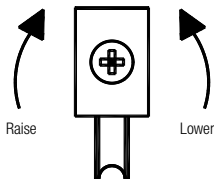

FIG. 20

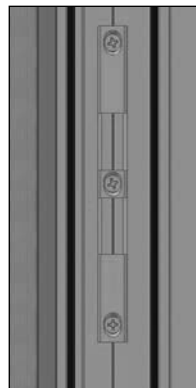

FIG. 21

### Step 10: Securing Stacking Panel (For Stacking Door Only)

- A) Use the included construction handle or a screwdriver to lock the stacking panel to the side jamb. This secures and fixes the stacking panel. **The stacking panel cannot be adjusted once it is locked.**
- B) Plug access hole with the provided hole cap as shown in Fig. 22.

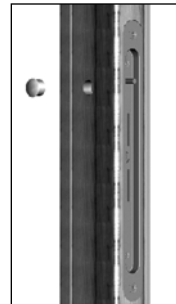

FIG. 22

### Step 11: Jamb Cover Installation

- A) Install L-brackets against the pocket/stacking panel and the intermediate panels in the closed position.
- B) Install the head jamb cover on the exterior facing tracks.
- C) Determine which track each cover goes into based on its overall length before installing.
- D) Make sure the track cover is tight against the side jamb and gently insert it in place. (Fig. 24)
- E) Install the side jamb track cover on the exterior of the locking side jamb by fitting it to the head jamb and gently insert it in place. (Fig. 23)

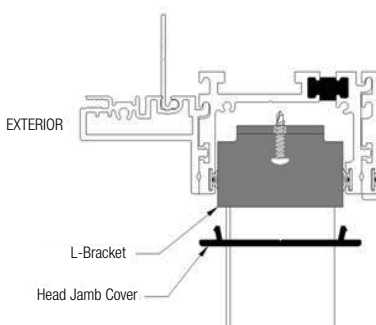

FIG. 23

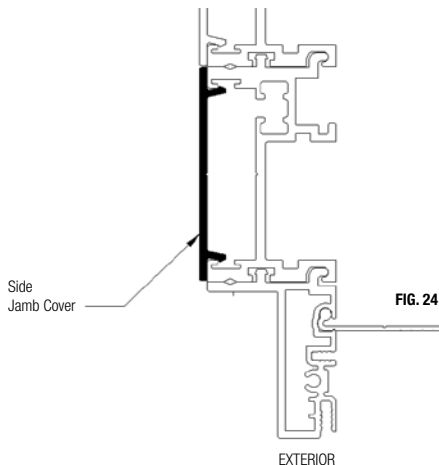

FIG. 24

## Step 12: Complete Flashing

- A) Cut and apply side flashing. Side flashing should run from the bottom of the sill flashing to 8" above the rough opening. (Fig. 25)
- B) If non-adhesive flashing is used, make sure all staple holes are sealed with silicone.
- C) Cut and apply head flashing. The head flashing should be on top of the drip cap flashing. The head flashing should run slightly past the edge of the side flashing. (Fig. 26)
- D) Flip down the top flap of the WRB.
- E) Tape the cut seams of the WRB. (Fig. 27)



FIG. 25



FIG. 26



FIG. 27

## Step 13: Seal the Exterior

- A) **WARNING:** Maintain a minimum of 1/4" between the door frame and any trim, siding or masonry. Failure to do so will forfeit all warranties (written or implied). Windsor Windows & Doors will not be held responsible for any claims or damages resulting from failure to follow these instructions.
- B) Apply a continuous bead of sealant at the joint between the side jambs and the sill and between the side jambs and the top jamb.

## Step 14: Complete the Interior

- A) Remove all labels or shipping materials.
- B) Various hardware adjustments may be required after installation. See the Care and Use Guide located at [www.windsorwindows.com](http://www.windsorwindows.com) for further details.
- C) Insulate between the door frame and the rough opening using minimally expanding window and door spray foam insulation. Use caution to not overfill the gap causing the jambs to bow. It is not recommended to apply trim to the unit until the foam has cured to allow the excess to escape.
- D) Operate door unit to ensure proper operation. The panel will not operate correctly if the door is out of square, over-shimmed or over-insulated.
- E) Properly finish all wood/cellular PVC interior and exterior components within 60 days of installation. See the Care and Use Guide located at [www.windsorwindows.com](http://www.windsorwindows.com) for further details on finishing Pinnacle multi-slide doors.
- F) **IMPORTANT:** Do not stain or paint any hardware or vinyl components.

- G) Apply the handle set as appropriate per manufacturers' recommendations. Complete final adjustments as necessary.
- H) Sliding doors are to remain closed and locked during construction to prevent site conditions from damaging and/or warping panels and frames. Allow 10-12 weeks from project completion for building temperature and humidity levels to stabilize and door panels to acclimate.

**If you have any questions regarding your Windsor Windows, please contact Windsor Windows & Doors directly at 1-800-218-6186.** Or you can visit us online at [www.windsorwindows.com](http://www.windsorwindows.com), where you will find helpful information as well as our Care and Use Guides, which will assist you in preserving your windows and patio doors. While you are at our site, you can also complete and submit the form on the Contact page, and one of our door specialists will promptly answer your question.

## Care and Use

For information about the care and use of your Windsor products, please visit the [www.windsorwindows.com/support](http://www.windsorwindows.com/support), and click "Warranty, Care & Installation," where you will find a link to our Care and Use Guide. Or contact your local independent Windsor distributor and ask for a copy of the Care and Use Guide, which contains information on finishing, cleaning, what to look for during yearly inspections, general maintenance tips, sash/panel adjustment, sash/panel removal, screen removal and information on condensation. You should inspect your doors annually.

## Warranties

**You can find a copy of our current Warranty at the website, under the "Support" tab.** If you have Windsor products that are older, please contact Windsor at 1-800-218-6186, and we will provide a copy of the applicable warranty.