

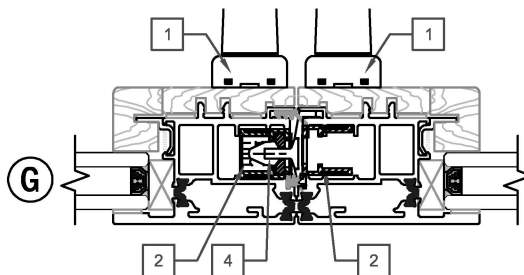

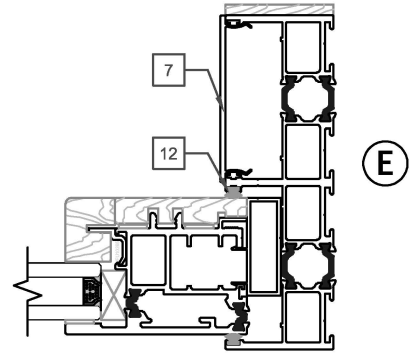

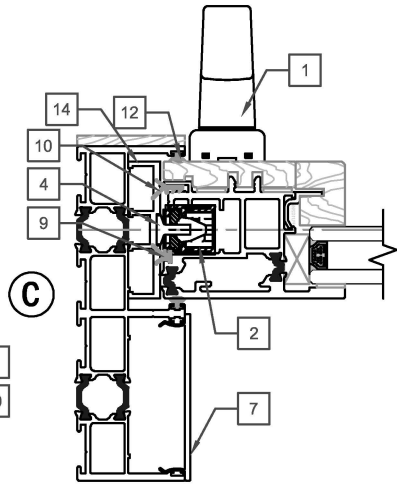

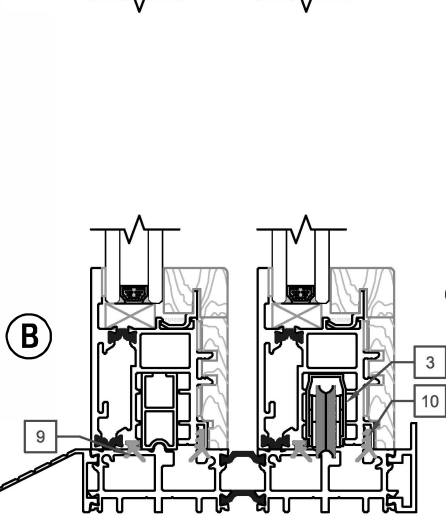

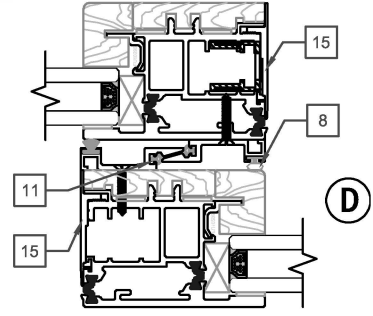
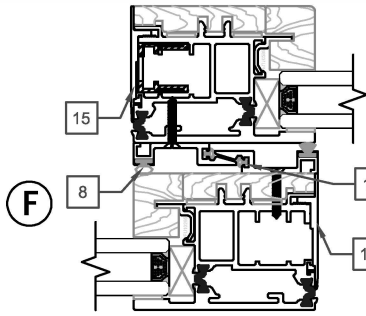
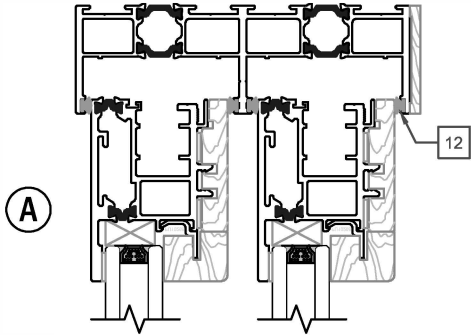
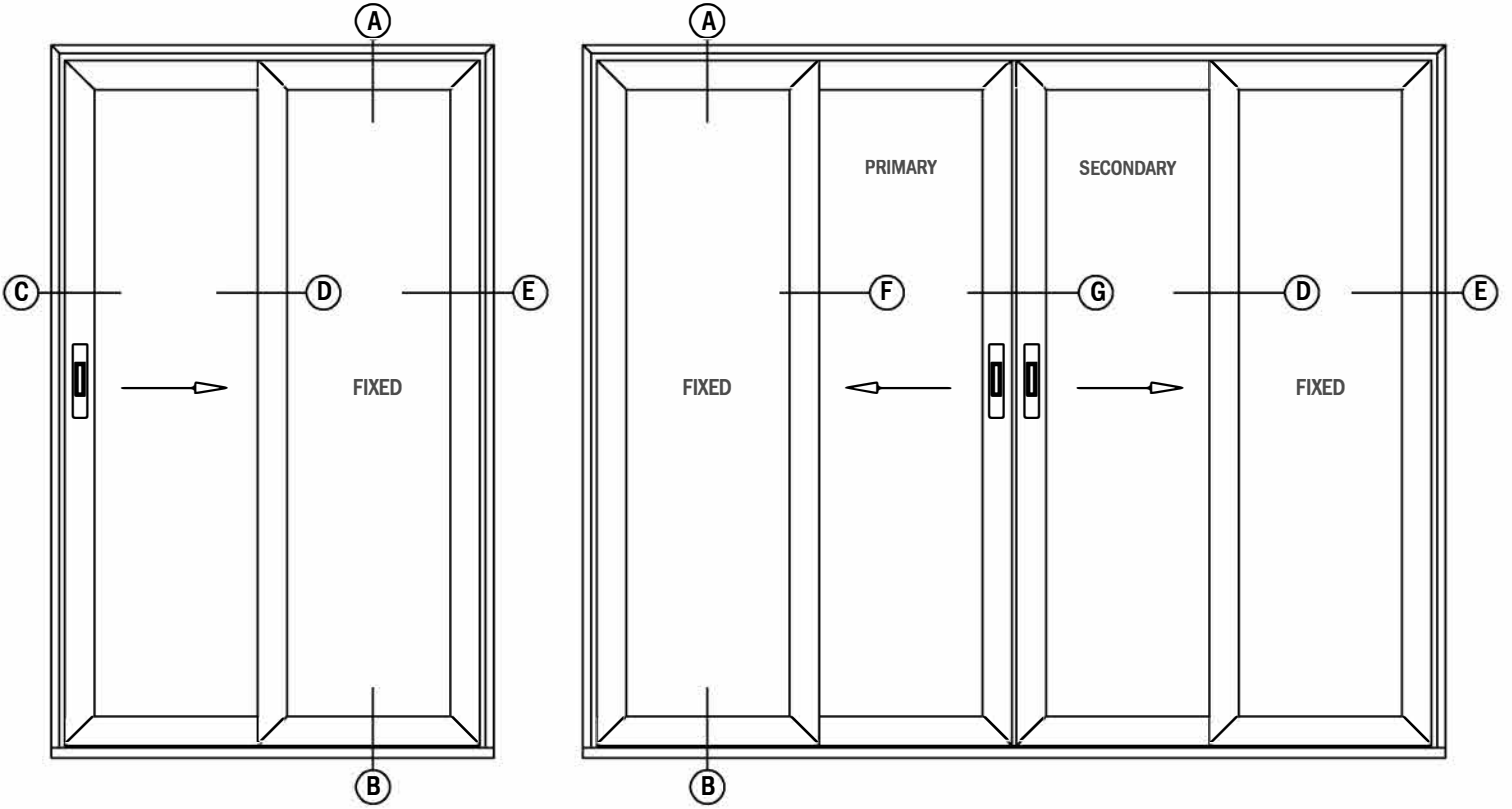



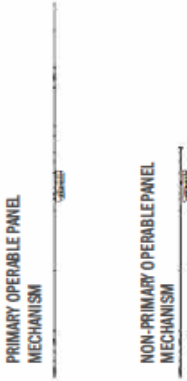

# PINNACLE SELECT LIFT & SLIDE (Wood Interior)

## PART LIST







# PINNACLE SELECT LIFT & SLIDE (Wood Interior)

## PART LIST

IMAGE	ITEM #	DESCRIPTION	TYPE	OLD	NEW SAP
	1	Q-ARTE (PRIMARY/SECONDARY PANEL)	DARK BRONZE SATIN CRHOME	48093 48094	10119095 10119096
	2	OPERABLE PANEL MECHANISM *WILL NEED PANEL SIZE	PRIMARY NON-PRIMARY  PRIMARY (COASTAL) NON-PRIMARY (COASTAL)	48095 48096  48108 48109	10119097 10119098  10120162 10120163
	3	L&S WHEEL SET *WILL NEED PANEL SIZE	GRAY WHITE (COASTAL)	48097 48110	10119071 10120164
	4	L&S POINT LOCKS	GRAY	48098	10119025
	5	INTERLOCK TOP CAP / BOTTOM CAP RIGHT STACK (EXT. VIEW) LEFT STACK (EXT. VIEW)	BLACK	48057	10120634
	5	INTERLOCK TOP CAP / BOTTOM CAP LEFT STACK (EXT. VIEW) RIGHT STACK (EXT. VIEW)	BLACK	48059	10120636
	7	SIDE FRAME/HEADER CAP	PC TO MATCH	48060	10120637
	8	INTERLOCK BUBBLE GASKET	GRAY	48099	10119086
	9	INT. GLAZING GASKET	BLACK	48036	10120613
	10	PANEL RAIL GASKET (EXTERIOR SIDE)	BLACK	48100	10119087
	11	PANEL RAIL GASKET (INTERIOR SIDE)	BLACK	48101	10119088
	12	INTERLOCK GASKET	BLACK	48061	10120638
	13	SMALL BASE FELT BRUSH (SIDE FRAME ONLY)	BLACK	48064	10134440

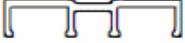
# PINNACLE SELECT LIFT & SLIDE (Wood Interior)

## PART LIST

IMAGE	ITEM #	DESCRIPTION	TYPE	OLD	NEW SAP
	14	LARGE BASE FELT BRUSH (SIDE FRAME ONLY)	BLACK	48065	10120640
	15	L&S SIDE FRAME ASTRAGAL	PC TO MATCH	48102	10119089
	16	PANEL COVER (LOCATED IN INTERLOCK SIDE)	PC TO MATCH	48103	10119090
	17	ADJUSTABLE KEY CORNER SIDE FRAME/HEADER KEY CORNERS	GRAY	48104	10119091
	18	REMOVEABLE HANDLE NON-PRIMARY PANEL HANDLE	PC WHITE PC BLACK PC SILVER	48105 48106 48107	10119092 10119093 10119094