

# Pinnacle Series

## Clad Double Hung - Concealed Jambliner

### Parts Identification

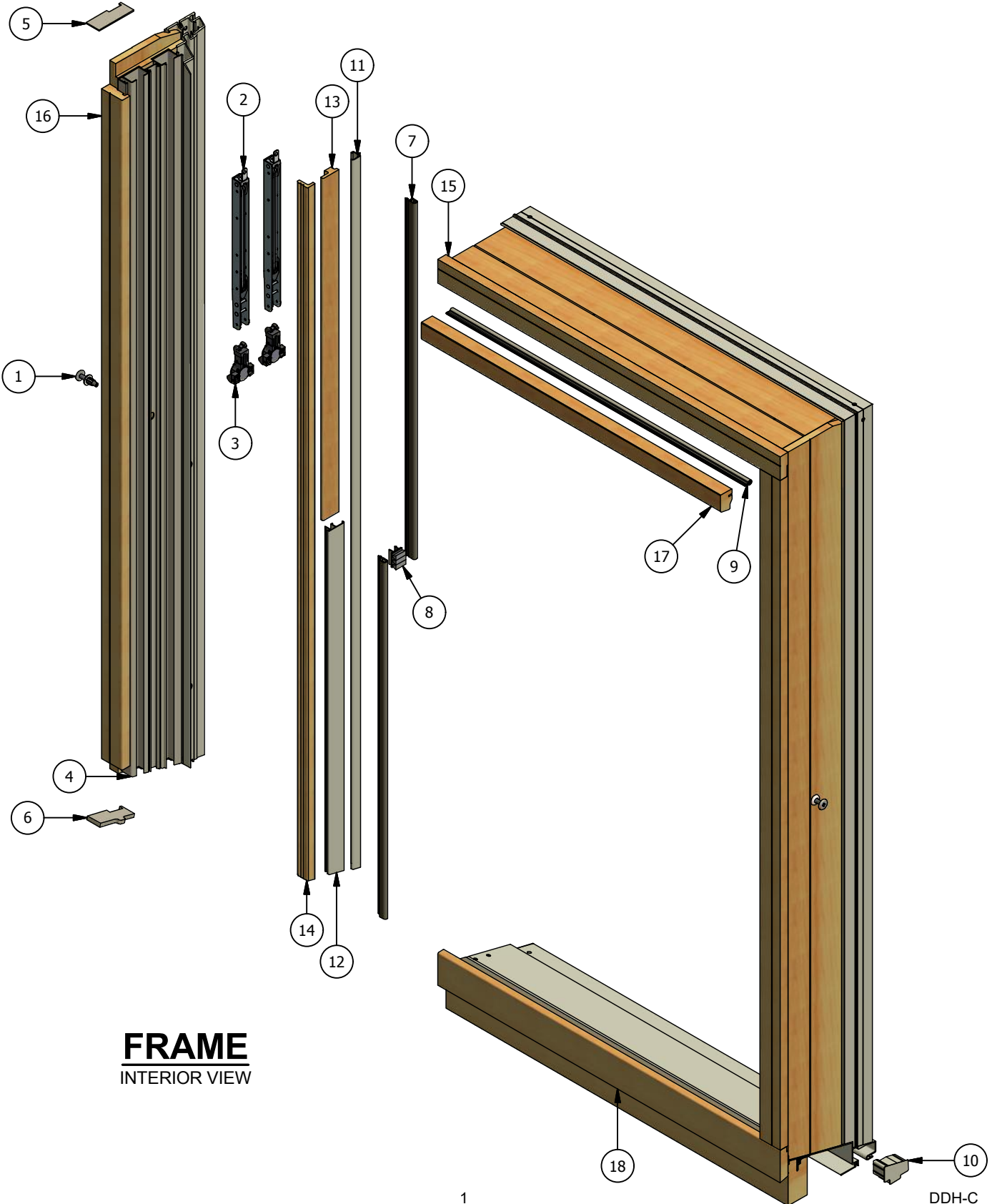

# Pinnacle Series

## Clad Double Hung - Concealed Jambliner

### Parts Identification

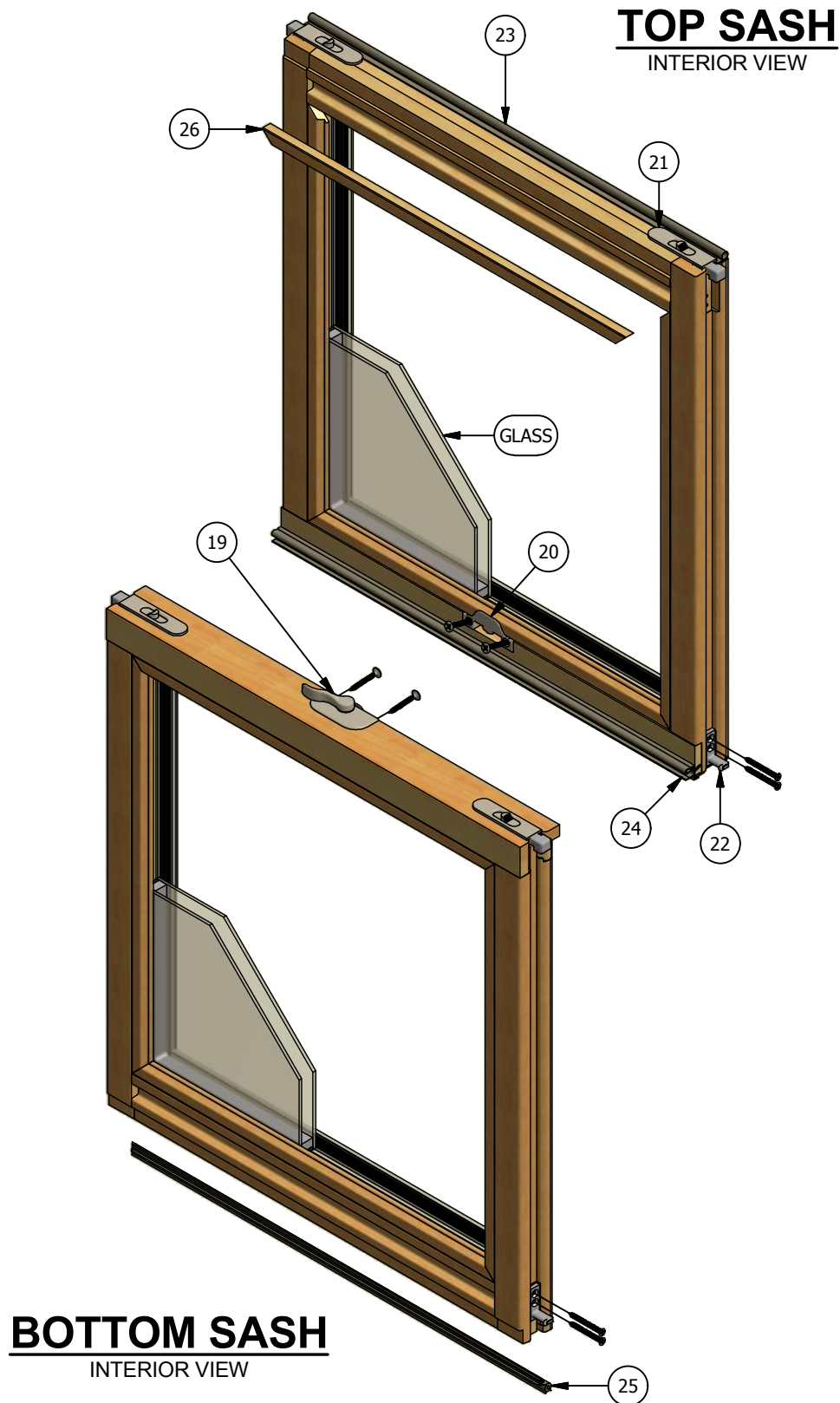





# Pinnacle Series

## Clad Double Hung - Concealed Jambliner

### Parts Identification

Image	Item #	Description	Color / Finish / Size	Spec	Old	New SAP
	1	Jamb Jack			558240	10054691
	2	Inverted Block and Tackle Balance	*See Inside Sales for more Information	08A 08B 10A 10B 10C 12A 12B 12C 12D 13B 13C 13D 14A 14B 14C 14D 15B 15C 15D 16A 16B 16C 16D 16E 17B 17C 17D 17E 18A 18B 18C 18D 18E	929000 929001 929005 929006 929007 929014 929015 929016 929017 929020 929021 929022 929023 929024 929025 929026 929031 929032 929033 929036 929037 929038 929039 929040 929057 929058 929059 929060 929076 929077 929078 929079 929080	10055688 10056515 10054731 10054881 10056741 10054635 10054732 10054562 10055283 10055690 10056519 10055076 10054793 10054733 10054636 10054734 10056520 10055691 10056521 10054587 10054735 10054637 10055284 10056522 10055692 10056523 10054977 10056743 10054736 10054542 10054794 10054737 10056524



# Pinnacle Series

## Clad Double Hung - Concealed Jambliner

### Parts Identification

Image	Item #	Description	Color / Finish / Size	Spec	Old	New SAP
	2	Inverted Block and Tackle Balance	*See Inside Sales for more Information	19B	929098	10054638
				19C	929099	10054738
				19D	929100	10055693
				19E	929101	10056525
				20A	929117	10054588
				20B	929118	10054795
				20C	929119	10054739
				20D	929120	10054639
				20E	929122	10056526
				21A	929140	10056527
				21B	929141	10055077
				21C	929142	10056528
				21D	929143	10055695
				21E	929144	10056529
				22A	929160	10054740
				22B	929161	10054563
				22C	929162	10054796
				22D	929163	10054741
				22E	929165	10056530
				22F	929166	10055696
				23B	929182	10054926
				23C	929183	10054640
				23D	929184	10054742
				23E	929185	10056744
				24A	929202	10054589
				24B	929203	10055697
				24C	929204	10054743
				24D	929205	10054641
				24E	929207	10054744
				24F	929208	10056533
25B	929226	10054552				
25C	929227	10055698				
25D	929228	10054797				
25E	929229	10056535				
25F	929230	10055079				
25H	929232	10055699				
26A	929296	10056541				
26B	929247	10056537				
26C	929248	10054642				
26D	929249	10054746				
26E	929251	10055288				
26F	929252	10056538				
27B	929269	10056539				
27C	929270	10054590				
27D	929271	10054978				
27E	929272	10056745				
27F	929273	10056540				



# Pinnacle Series

## Clad Double Hung - Concealed Jambliner

### Parts Identification



Image	Item #	Description	Color / Finish / Size	Spec	Old	New SAP
	2	Inverted Block and Tackle Balance	*See Inside Sales for more Information	28A	929289	10054747
				28B	929290	10054643
				28C	929291	10054748
				28D	929292	10054564
				28E	929294	10054798
				28F	929295	10055701
				29B	929312	10056542
				29C	929313	10055702
				29D	929314	10056543
				29E	929316	10055080
				29F	929317	10056544
				30A	929333	10054749
				30B	929334	10054644
				30C	929335	10056545
				30D	929336	10054750
				30E	929338	10055290
				30F	929339	10056546
				31B	929356	10056547
				31C	929357	10054902
				31D	929358	10056746
				31E	929359	10054591
				32A	929370	10054751
				32B	929371	10054645
				32C	929372	10055705
				32D	929373	10054752
				32E	929375	10056549
				32F	929376	10054545
				32G	929377	10055291
				32H	929378	10056550
				33C	929388	10056747
				33D	929389	10056552
				33E	929390	10055707
				33F	929391	10056553
				34B	929402	10054979
				34C	929403	10054753
34D	929404	10054646				
34E	929406	10056748				
34F	929407	10056556				
34G	929408	10055709				
34H	929409	10056557				
35C	929419	10055710				
35D	929420	10056559				
35E	929421	10055082				
35F	929422	10056560				
35G	929423	10055711				
35H	929424	10056561				



# Pinnacle Series

## Clad Double Hung - Concealed Jambliner

### Parts Identification



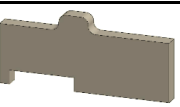

Image	Item #	Description	Color / Finish / Size	Spec	Old	New SAP
	2	Inverted Block and Tackle Balance	*See Inside Sales for more Information	36B	929433	10056749
				36C	929434	10054754
				36D	929435	10054592
				36E	929437	10056564
				36F	929438	10055713
				36G	929439	10056565
				37C	929450	10055714
				37D	929451	10056567
				38B	929464	10054980
				38C	929465	10056750
				38D	929466	10054800
				38E	929467	10056572
				38F	929468	10055717
				38G	929469	10056573
				38H	929470	10055297
				38I	929471	10056574
				39C	929479	10056576
				39D	929480	10055719
				39E	929481	10056577
				39F	929482	10055298
				40C	929494	10055721
				40D	929495	10056581
				40E	929497	10054755
				40F	929498	10055299
				40G	929499	10056582
				40H	929500	10055722
				40I	929501	10056583
41F	929513	10056585				
41H	929514	10055300				
42E	929526	10056588				
42F	929527	10055725				
44C	929554	10056596				
44D	929555	10055729				
44DS	929556					
44E	929557	10056597				
44F	929558	10055303				
44G	929559	10056598				
44H	929560	10055730				
44JL	929562	10055087				
		Balance Screw (#6 x 5/8")			583125	10053112
	3	Balance Shoe			931175	10055304



# Pinnacle Series

## Clad Double Hung - Concealed Jambliner

### Parts Identification

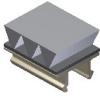
Image	Item #	Description	Color / Finish / Size	Spec	Old	New SAP
	4	Jambliner Shell	14" (Glass Size)	LH	583101-L	10055229
				RH	583101-R	10056299
			16"	LH	583102-L	10054697
				RH	583102-R	10054617
			20"	LH	583103-L	10055583
				RH	583103-R	10056300
			22"	LH	583104-L	10056709
				RH	583104-R	10056301
			24"	LH	583105-L	10056302
				RH	583105-R	10055230
			26"	LH	583106-L	10055584
				RH	583106-R	10056303
			28"	LH	583107-L	10056304
				RH	583107-R	10055585
			30"	LH	583108-L	10054698
				RH	583108-R	10054578
32"	LH	583109-L	10056305			
	RH	583109-R	10055231			
34"	LH	583110-L	10056306			
	RH	583110-R	10055586			
36"	LH	583111-L	10056307			
	RH	583111-R	10054964			
9' Lineal					583100	10055582
	5	Jambliner Head Pad		LH/RH	583119 583120	N.L.A 10055052
	6	Jambliner Sill Pad		LH/RH	583117 583118	N.L.A 10056311
	7	Jambliner Weatherstrip	Beige Bronze		583151 583150	10056316 10055594
	8	Center Transition Cover			583149	10088391



# Pinnacle Series

## Clad Double Hung - Concealed Jambliner

### Parts Identification

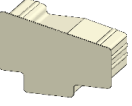
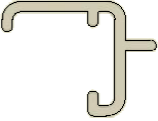
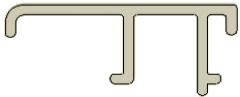
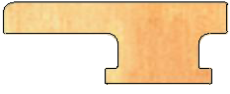
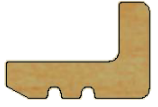
Image	Item #	Description	Color / Finish / Size	Spec	Old	New SAP
	9	Parting Stop Weatherstrip			583114	10056310
	10	Sill End Plug (LH Shown)	White Bronze Tan Ivory Hunter Green Black Cinnamon	LH RH LH RH LH RH LH RH LH RH	530038 530041 530039 530042 530040 530053 531082 531083 530058 530059 530054 530055 530056 530057	10055547 10056228 10056227 10055548 10055211 10056229 10054917 10056699 10056231 10055212 10054959 10056698 10056230 10055549
	11	Exterior Jambliner Cover	Mill Finish*		583008	10057620
	12	Lower Center Jambliner Cover	Mill Finish*		583016	10057187
	13	Upper Center Jambliner Cover	6' Pine Lineal 6' Alder Lineal 6' Fir Lineal		2386901 2386901-A 2386901-F	10017799 10017800 10017801
	14	Interior Jambliner Cover	9' Pine Lineal 9' Alder Lineal 9' Fir Lineal		2386907 2386907-A 2386907-F	10017813 10017814 10056032

\*When ordering aluminum lieals in 2604 or 2605 standard or feature color, please order the mill part number to that extrusion, then specify color and either 2604 or 2605 finish.







# Pinnacle Series

## Clad Double Hung - Concealed Jambliner

### Parts Identification

Image	Item #	Description	Color / Finish / Size	Spec	Old	New SAP
	15	Head Inside Stop	16" Pine (Glass Size)		583080	10024206
			20" Pine		583081	10024207
			24" Pine		583082	10024208
			26" Pine		2480287	10017853
			28" Pine		583083	10024209
			30" Pine		2480250	10017841
			32" Pine		583084	10024210
			36" Pine		583085	10024211
			40" Pine		583086	10024212
			5' Pine Lineal		2386905	10017807
			5' Alder Lineal		2386905-A	10017808
			5' Fir Lineal		2386905-F	10017809
				16	Side Inside Stop	14" Pine (Glass Size)
16" Pine		583070				10024196
20" Pine		583071				10024197
22" Pine		583072				10024198
24" Pine		583073				10024199
26" Pine		583074				10024200
28" Pine		583075				10024201
30" Pine		583076				10024202
32" Pine		583077				10024203
34" Pine		583078				10024204
36" Pine		583079				10024205
9' Pine Lineal		2381965				10017680
9' Alder Lineal		2381965-A				10017681
9' Fir Lineal		2381965-F				10055834



\*When ordering aluminum lieals in 2604 or 2605 standard or feature color, please order the mill part number to that extrusion, then specify color and either 2604 or 2605 finish.



# Pinnacle Series

## Clad Double Hung - Concealed Jambliner

### Parts Identification

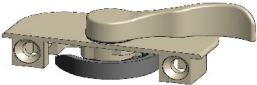
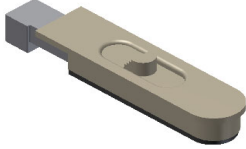
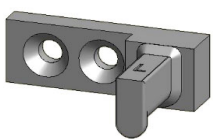
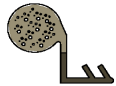

Image	Item #	Description	Color / Finish / Size	Spec	Old	New SAP
	17	Parting Stop	16" Pine (Glass Size) 20" Pine 24" Pine 28" Pine 32" Pine 36" Pine 40" Pine 5' Pine Lineal 5' Alder Lineal 5' Fir Lineal		583062 583063 583064 583065 583066 583067 583068 2386902 2386902-A 2386902-F	10024188 10024189 10024190 10024191 10024192 10024193 10024194 10017802 10017803 10017804
	18	Sill Inside Stop	16" Pine (Glass Size) 20" Pine 24" Pine 26" Pine 28" Pine 30" Pine 32" Pine 36" Pine 40 Pine 11' Pine Lineal 8' Alder Lineal 11' Fir Lineal  11' Pine Lineal - High Performance 8' Alder Lineal - High Performance 6' Fir Lineal - High Performance		2530187 2530188 2530189 2480288 2530190 2480251 2530191 2530192 2530193 2530200 2530200-A 2530200-F  2370093 2370093-A 2370093-F	10017931 10017932 10017937 10017854 10017938 10017842 10017939 10017940 10017941 10017946 10044693 10057385  10017307 10057263 10056885
	19	Lock with Screws	White Champagne Bronze Oil Rubbed Bronze Satin Nickel Brass Black Faux Bronze		2382700 2382701 2382702 2382703 2382704 2382705 2382706 2382734	10055838 10055116 10055839 10055354 10055840 10054905 10056640 10055854



# Pinnacle Series

## Clad Double Hung - Concealed Jambliner

### Parts Identification







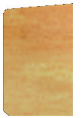

Image	Item #	Description	Color / Finish / Size	Spec	Old	New SAP
	20	Keeper with Screws	White		2382710	10055841
			Champagne		2382711	10055355
			Bronze		2382712	10055842
			Oil Rubbed Bronze		2382713	10055117
			Satin Nickel		2382714	10055843
			Brass		2382715	10055356
			Black		2382716	10055844
			Faux Bronze		2382735	10055360
	21	Tilt Latch with Screws (LH Shown) (Top & Bottom Sash)	White	LH	583126	10056317
				RH	583134	10055234
			Champagne	LH	583127	10055590
				RH	583135	10056321
			Bronze	LH	583128	10056318
				RH	583136	10055592
			Oil Rubbed Bronze	LH	583129	10054899
				RH	583137	10056322
			Satin Nickel	LH	583130	10056711
				RH	583138	10055053
			Brass	LH	583131	10056319
				RH	583139	10056712
			Black	LH	583132	10055591
				RH	583140	10056323
Faux Bronze	LH	583133	10056320			
	RH	583141	10055593			
	22	Tilt Pin (LH Shown)		LH	583142	10056314
				RH	583143	10055235
		Tilt Pin Screws				8094
	23	Top Rail Weatherstrip			2381375	10055813
	24	Check Rail Weatherstrip	Beige:			
			24"		2381656	10056638
			28"		2381657	10055829
			32"		2381658	10055349
			36"		2381662	10055114
			6' Lineal Length		2381659	10055830
			Black:			
			24"		2381705	10055832
			28"		2381706	10054934
			32"		2381707	10056639
36"		2381708	10055833			
6' Lineal		2381709	10055351			



# Pinnacle Series

## Clad Double Hung - Concealed Jambliner

### Parts Identification

Image	Item #	Description	Color / Finish / Size	Spec	Old	New SAP
	25	Bottom Rail Weatherstrip	Beige Bronze		2381381 2381382	10055110 10055815
 Not Shown on Assembly Dwg		Clear Drip Cap	14' Lineal Length		471005	10053169
 Not Shown on Assembly Dwg		Side Nail Fin	14' Lineal Length		460015	10053253
 Not Shown on Assembly Dwg		Sill Nail Fin	14' Lineal Length		460020	10053126
 Not Shown on Assembly Dwg		Nail Fin Gasket	4 per Sheet		490013	10053171
	26	Ogee Glass Stop	8' Pine Lineal 8' Alder Lineal 6' Fir Lineal		2381090 2381090-A 2381090-F	10017516 10017517 10017518
		Glazing Tape	Black - 216 ft Roll		2381420	10055818
 Not Shown on Assembly Dwg		Contemporary Glass Stop	8' Pine Lineal 8' Alder Lineal 8' Fir Lineal		2922303 2922303-A 2922303-F	10020721 10020722 10057394
		Glazing Tape	Black - 216 ft Roll		2381420	10055818
 Not Shown on Assembly Dwg		Window Opening Control Device (Includes screws & Instructions) Field Applied Only	Bronze  White		9410012  9410013	10055733  10056605