

# Next Dimension Signature Series

## Double Hung (Operating)

### Parts Identification

#### TOP SASH

INTERIOR VIEW

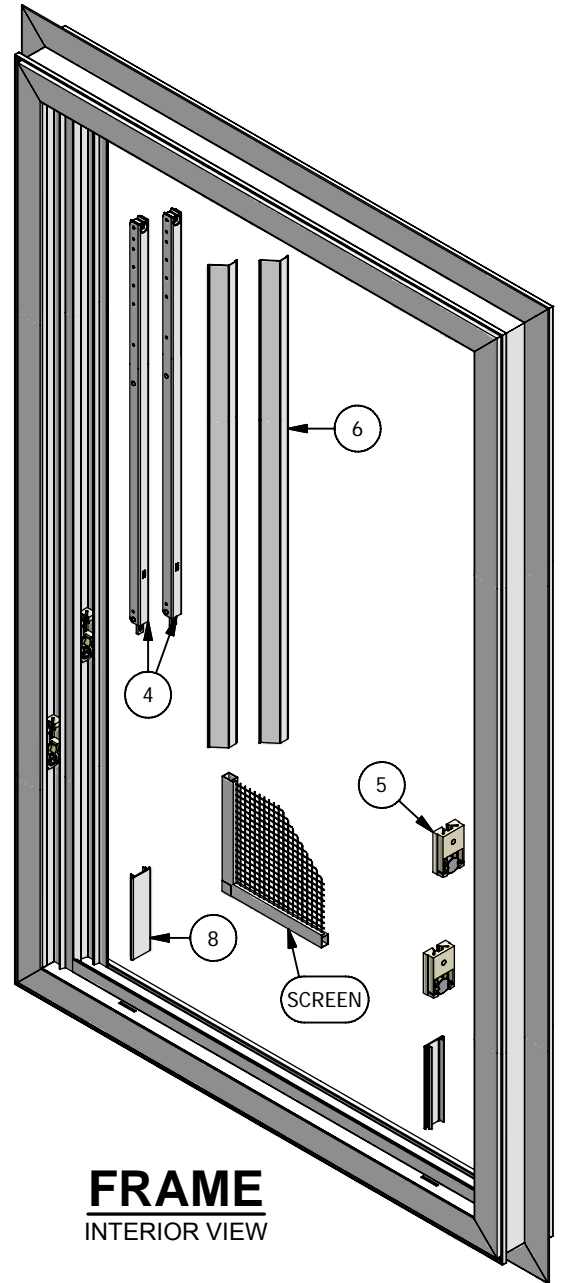
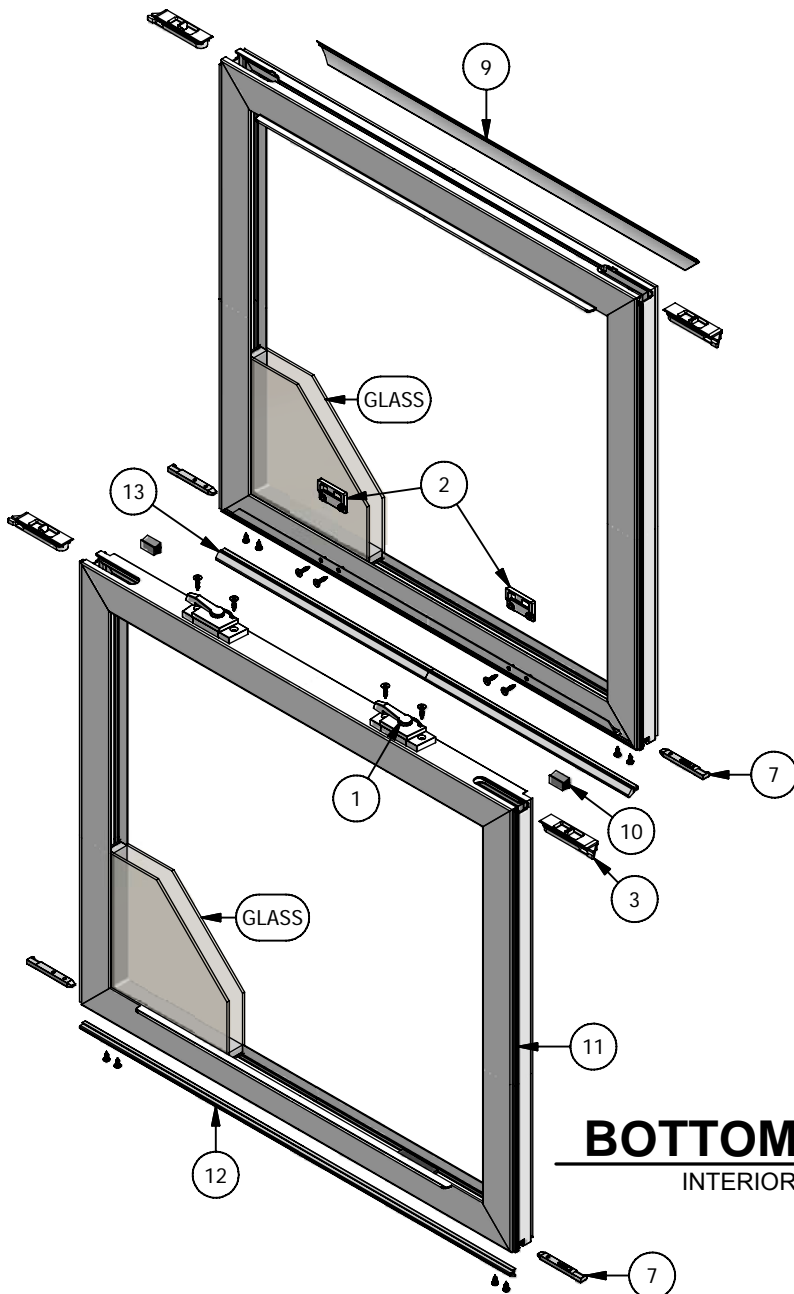

#### FRAME

INTERIOR VIEW

#### BOTTOM SASH

INTERIOR VIEW



# Next Dimension Signature Series

## Double Hung (Operating)

### Parts Identification

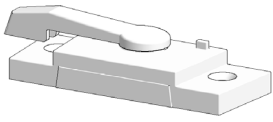
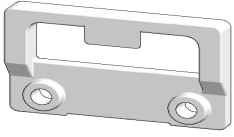
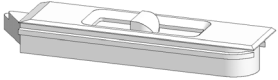
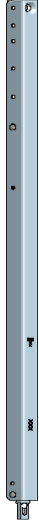



Image	Item #	Description	Color / Finish	Spec	Old	New SAP
	1	Lock	White Almond Clay		558166 558160 558168	10054342 10057612 10054204
		Lock Screws #6 x 7/8 Screw (Qty 2)	White Almond Clay		508181 508182 538182	10056206 10074317 10056254
	2	Keeper	White Almond Clay		558167 558231 558169	10054688 10054548
		Keeper Screws #6 x 5/8 Screw (Qty 2)	White Almond Clay		508085 508080 538080	10056199 10056701
	3	Tilt Latch	White White Almond Almond Clay Clay	LH RH LH RH LH RH	558234 558235 558236 558237 558316 558315	10054690 10054576 10054558 10054210
			Balance	10A 12A 12B 14A 14B 14C 16A 16B 16C 18A 18B 18C 20A 20B 20C 20D 22A 22B 22C		421440 421455 421460 421470 421475 421480 421485 421490 421495 421500 421505 421510 421515 421520 421525 421530 421535 421540 421545
	4					
			<i>Continued on Next Page</i>			



# Next Dimension Signature Series

## Double Hung (Operating)

### Parts Identification



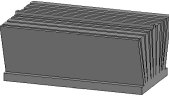

Image	Item #	Description	Color / Finish	Spec	Old	New SAP
	4	Balance	<i>Continued from Previous Page</i>			
			24A	421550	10054168	
			24B	421555	10135361	
			24C	421560	10054601	
			24D	421565	10135362	
			26A	421570	10135363	
			26B	421575	10054291	
			26C	421580	10054169	
			26D	421585	10135364	
			28A	421590	10135365	
			28B	421595	10054292	
			28C	421600	10054666	
			28D	421605	10054570	
			30A	421609	10135366	
			30B	421610	10135367	
			30C	421615	10057106	
			30D	421620	10054293	
			32A	421625	10135368	
			32B	421630	10054170	
			32C	421635	10054774	
			32D	421640	10054294	
34A	421645	10135369				
34B	421650	10125555				
34C	421655	10054171				
34D	421660	10054667				
36B	421670	10125556				
	5	Balance Shoe			421690	10054602
	6	Pocket Cover (Top)	White	13'	900735	10054245
Almond			13'	900835		
Clay			13'	901835	10054151	
	7	Tilt Pin			421695	10054668
Tilt Pin Screws						
#6 x 5/8" Screw (Qty 1)		White Flat Head Screw	508085	10056199		
#6 x 5/8" Screw (Qty 1)		Clay Flat Head Screw	538080	10056701		
#6 x 3/8" Screw (Qty 1)	Zinc Pan Head Screw	508183	10055540			



# Next Dimension Signature Series

## Double Hung (Operating)

### Parts Identification

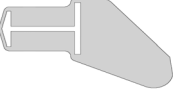
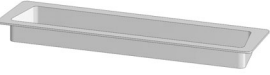
Image	Item #	Description	Color / Finish	Spec	Old	New SAP
	8	Pocket Cover (Bottom)	White Almond Clay	13' 13' 13'	900740 900840 901840	10054395
	9	Glazing Bead	White Almond Clay Bronze Black Tan Ivory Cinnamon Green White	13'	900043 900110 901043 900043-BZ 900043-BK 900043-T 900043-I 900043-C 900043-G 900043-W	10054560 10054247 10116543 10055281 10116540 10116542 10116541 10116538 10116539
	10	Dust Pad	Grey		5800000	10054355
	11	Weatherstrip (Tri-Fin)	White Clay Black	LF LF LF	478067 478073 531102	10057107 10054322 10057173
	12	Weatherstrip (V-Fold) (Bottom Rail Only)	White Beige	LF LF	531098 531099	10054682 10054331
	13	Weatherstrip (Keeper Rail Only)	White Almond Clay Black	LF LF LF LF	531090 531091 531096 531103	10054610 10088496
 Not Shown on Assembly Dwg		Egress Sash Lift	White Almond Clay		558232 558233 545233	10054347 10088295
No Image		Glazing Tape 1/16" x 1/2"	White	216' Roll	394100	10055200



# Next Dimension Signature Series

## Double Hung (Operating)

### Parts Identification

Image	Item #	Description	Color / Finish	Spec	Old	New SAP
 <p>Not Shown on Assembly Dwg</p>		Window Opening Control Device (Includes screws & Instructions) Field Applied Only	White Clay		941008 941009	10054649 10054760