

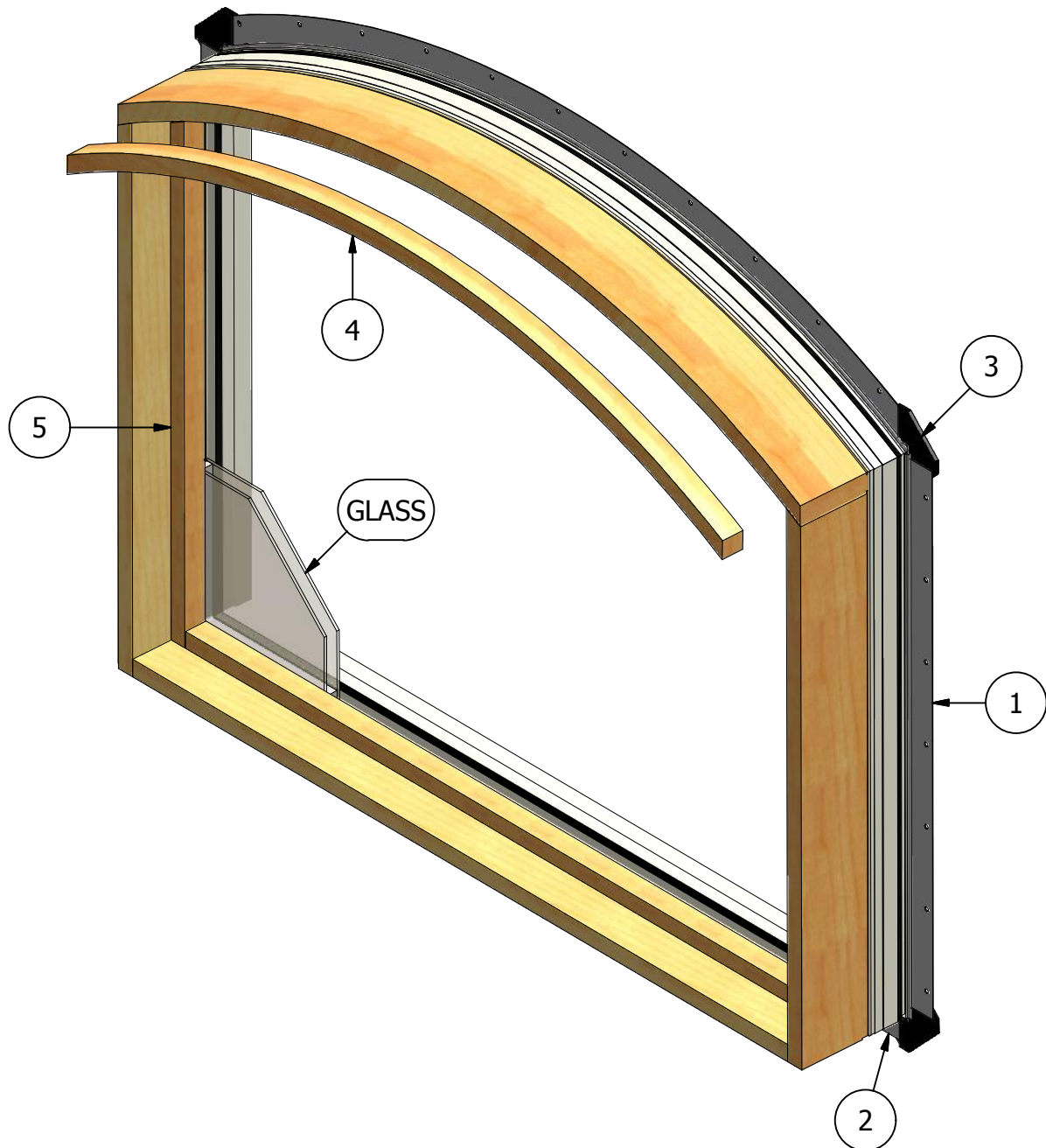

Pinnacle Series

Clad Radius & Low Profile Direct Set

Parts Identification









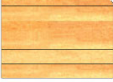

Pinnacle Series

Clad Radius & Low Profile Direct Set

Parts Identification

Image	Item #	Description	Color / Finish / Size	Spec	Old	New SAP
	1	Side Nail Fin - Slotted			460015	10053253
	2	Sill Nail Fin			460020	10053126
	3	Nail Fin Gasket	4 per Sheet		490013	10053171
	4	Radius Inside Stop			* See Note Below	* See Note
	5	Inside Stop (Sill & Sides) Glass Stop Tape	16' Pine Lineal 8' Alder Lineal 10' Fir Lineal Black - 150' Roll		2370474 2370474-A 2370474-F 390531	10017310 10017311 10056886 10055523
 *Not shown in assembly model		Contemporary Inside Stop (Sill & Sides)	Radius 14' Pine Lineal Alder Lineal Fir Lineal		*See Note 773986 773986-A 773986-F	*See Note 10042379 10120252 10057831
 *Not shown in assembly model		3 1/4" Frame Inside Stop (Sill & Sides)	Radius 14' Pine Lineal Alder Lineal Fir Lineal		*See Note 773988 773988-A 773988-F	*See Note 10054043 10088806 10088807

* When ordering replacement parts for radius units, include the following information:

- Frame type (standard Pinnacle or 3 1/4" frame)
- Frame base measured from base outside of frame to outside of frame
- Frame height measured from outside of base to top of hights point of radius at head
- If the unit has vertical legs, measure from base to top of leg where radius starts